

Article number: 12503000030100
Description: KLEE-coil 503 000 030.100
M3 Hardened, zinc-pl./chr. yellow

Measures

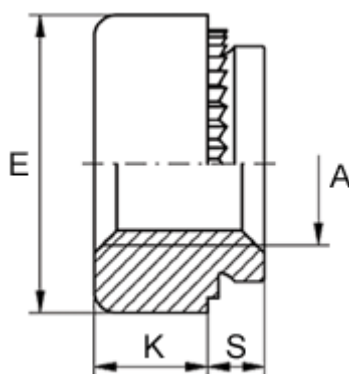

Female thread A	= M3
Height K	= 2.0
Max recess height	= 2.0
Min distance to edge	= 4.0
Outer diameter E	= 7.0
Plate thickness	= from 2.4
Recommended bore diameter +0.05	= 5.00